

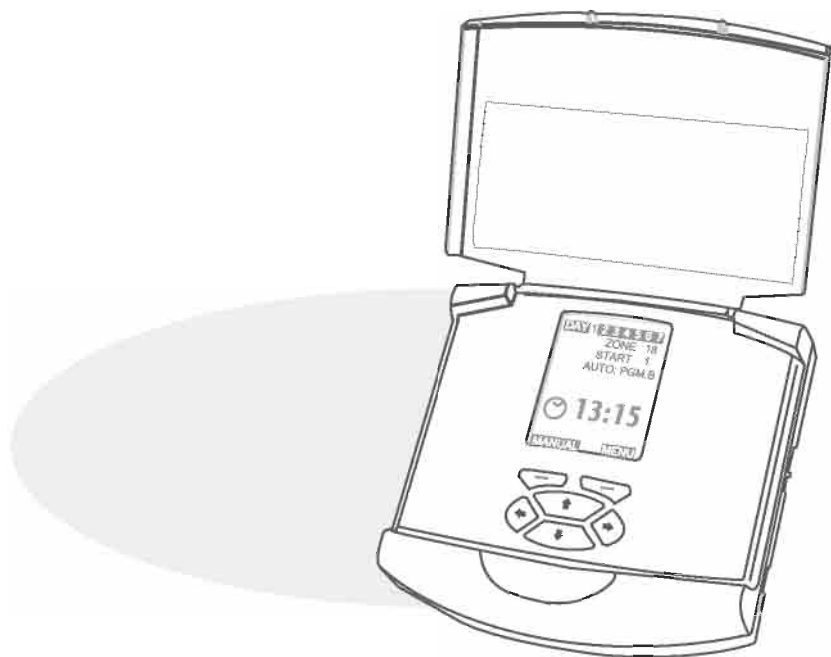

Merav

Multi-Zone AC Irrigation Controller

for 24VAC solenoid valve only



Users Guide

Table of Contents

GETTING STARTED	4
FEATURES	4
<i>Up to 8 valves plus Master Valve</i>	<i>4</i>
<i>Four Start Times for Each Valve</i>	<i>4</i>
<i>Programs Specific days or Intervals</i>	<i>4</i>
<i>Sensor</i>	<i>4</i>
<i>Rain Delay</i>	<i>4</i>
<i>Six Languages</i>	<i>5</i>
<i>Seasonal Changes in Irrigation Quantities</i>	<i>5</i>
<i>Pump Operation</i>	<i>5</i>
<i>Non-Volatile Memory</i>	<i>5</i>
<i>Easy-to-Read Screen Display</i>	<i>5</i>
<i>Screen Table of Programmed Irrigations</i>	<i>5</i>
PARTS IDENTIFICATION	6
<i>Screen Display</i>	<i>6</i>
<i>Function Buttons</i>	<i>6</i>
<i>Wall or Pipe Mount</i>	<i>7</i>
<i>Solenoid and Sensor Connections</i>	<i>7</i>
<i>Battery</i>	<i>7</i>
<i>Reset Button</i>	<i>7</i>
INSTALLATION	8
<i>Selecting a Location</i>	<i>8</i>
<i>Mounting Controller</i>	<i>8</i>
<i>Connecting Solenoids to Controller</i>	<i>9</i>
<i>Connecting Valves to Solenoids</i>	<i>9</i>
<i>Connecting a Sensor</i>	<i>9</i>
<i>Completing Installation</i>	<i>10</i>
<i>Making an Irrigation Schedule</i>	<i>10</i>
PROGRAMMING THE CONTROLLER	11
SETTING MAIN FUNCTIONS	11
<i>Using the Keys</i>	<i>11</i>
<i>Setting the Clock</i>	<i>12</i>
<i>Setting the Day</i>	<i>12</i>
<i>Setting the Start Times for Programs A and B</i>	<i>13</i>
<i>Calculating Irrigation and Duration Times</i>	<i>14</i>

Merav - AC Multi-Zone Controller

<i>Setting the Duration and Selecting Starts for Programs A and B</i>	14
<i>Selecting the Program</i>	16
<i>Selecting Irrigation Days</i>	17
OTHER FUNCTIONS	18
<i>Manual Operation</i>	18
<i>Viewing Programmed Table</i>	19
<i>Setting Rain Delay</i>	20
<i>Seasonal Adjustment</i>	21
<i>Off</i>	22
<i>Run-Test</i>	22
<i>Sensor</i>	23
<i>Setting Maximum Number of Zones</i>	23
<i>Selecting a Language</i>	24
<i>Restoring Default Settings</i>	25
TROUBLESHOOTING	26
IRRIGATION TABLES	27
Program A	27
Program B	27
Default settings for Program A	28
Default settings for Program B	28
CONTACT AND SERVICE INFORMATION	29
Guarantee	29
CONTACT INFORMATION	30

Getting Started

Features

Up to 8 valves plus Master Valve

Turns up to 8 valves (or zones) on and off automatically, according to programmed days and times.

Four Start Times for Each Valve

Each valve may be programmed to irrigate up to four times a day. The times programmed refer to all valves.

Programs Specific Days or Intervals

You may program irrigation to start on specific days (e.g. Mondays and Thursdays), or at specific intervals (e.g. every second day).

Sensor

A sensor may be connected to the Controller to determine the moisture level in the soil. If the sensor detects sufficient moisture the related valves are automatically closed.

Rain Delay

This function allows you to delay irrigating for up to 14 days if there has been sufficient rain. All previously set programs are retained, and irrigation will resume as before, after set number of days has passed.

Six Languages

Screen display may be set to one of six languages: English, French, Spanish, Italian, Portuguese and Hebrew.

Seasonal Changes in Irrigation Quantities

You may quickly and easily change duration times of all zones to adjust for changes in the weather. Increasing or decreasing percentages will adjust duration times according to your needs, so for example, all irrigation duration times will be cut in half if you select 50%.

Pump Operation

Allows operating a pump or a master valve controlling the whole area.

Non-Volatile Memory

The Controller retains programmed information in the event of a battery being removed and 24VAC failure.

Easy-to-Read Screen Display

Large screen and display enable easy programming and viewing information.

Screen Table of Programmed Irrigations

On screen table enables quick review of set programs.

Parts Identification

Screen Display

The screen display automatically turns off when not in use for 5 minutes. Touch any button to activate. The basic display shows current time, current day of the week, and chosen

Other chosen functions, such as rain delay, seasonal or manual operation are also displayed on the screen.

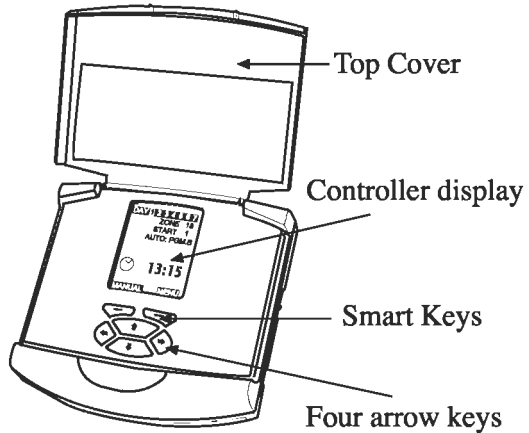

Function Buttons

These keys refer to the actions displayed on the screen directly above them.

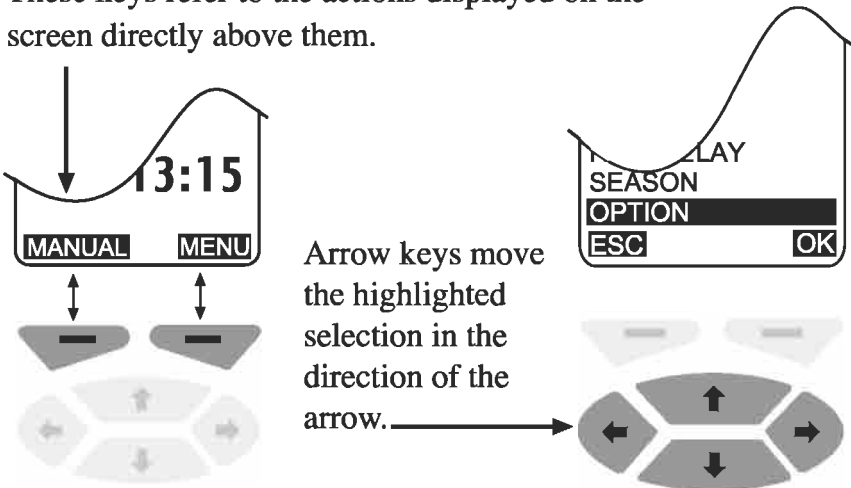

Merav - AC Multi-Zone Controller

UP ARROW

is also used to make a selection

DOWN ARROW

is also used to cancel a selection.

Wall or Pipe Mount

The Controller may be mounted on a wall or pipe using the wall bracket provided.

Solenoid and Sensor Connections

Terminals for connecting a sensor and valves/zones are on the rear of the Controller. Unscrew the long plate to connect. The solenoids are latch solenoids, 9V.

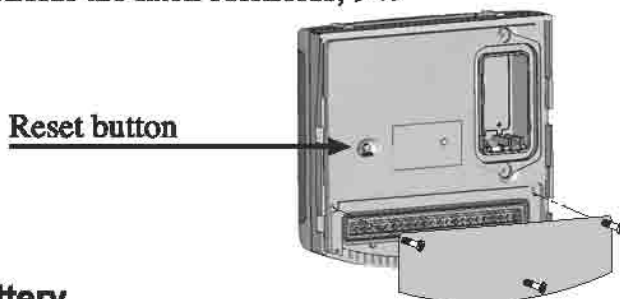

Battery

Use 9V alkaline battery. Duracell or Energizer batteries are recommended. The battery will keep the time during a 24VAC failure.

Reset Button

The Reset button is the small, red button located on the back of the unit. Set programs are retained even if the reset button is pressed. Only the clock needs to be set.

Installation

Selecting a Location

The Controller should be placed near the valves. It is water resistant, but should not be immersed in water. It may be mounted on a wall or on a pipe. Avoid direct sunlight. Temperature should not exceed 50 degrees C.

Mounting Controller

To mount Controller on the wall, mark the distance between the holes on the bracket and place two screws in the wall. To mount on a pipe use plastic fasteners to hold in place.

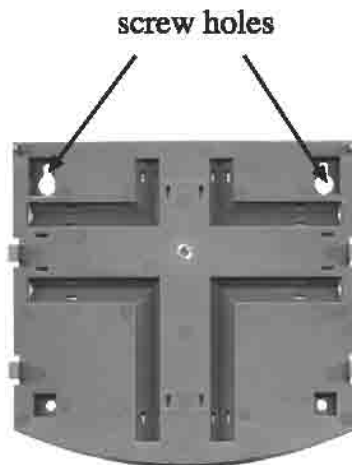

Connecting Solenoids to Controller

1. Unscrew back plate
2. Bring solenoid wires through conduit paths on the bottom of the Controller.
3. Unscrew the terminals marked 1 +. Push the wires from solenoid no. 1 into the holes on the seal under the screws, Black to ①, Green to ② and then tighten.

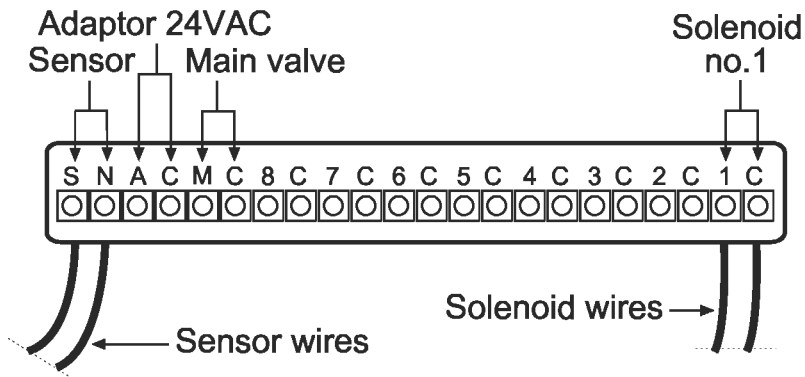

4. Continue till all solenoids are connected to appropriate terminals.
5. Connect main valve wires to terminal M + .
6. Connect adaptor to terminal AC.

Connecting Valves to Solenoids

Connect each valve to the appropriate solenoid.

Connecting a Sensor

1. Bring the sensor wires through the conduit paths in the bottom of the Controller
2. Unscrew the terminal marked SN. Push the wire from sensor in under the screw and tighten

Completing Installation

1. Check that all valves, solenoids and the sensor are connected correctly.
2. Replace back plate and screw tight.
3. Open main water valve, press Reset Red Button.
4. Place the Controller over the mounting plate and slide it into place.

Making an Irrigation Schedule

Use the tables printed on pages 27 and 28 to assist in making your irrigation schedule. We suggest you photocopy the table. Remember to take into account the maximum number of valves/zones that may operate together.

Programming the Controller



Setting Main Functions

Touch any key to activate the screen display.

NOTE: Remember to press **OK** after changing selections to confirm your choice. If not confirmed, the programmer will revert to the previous value.

Irrigation **WILL ONLY BEGIN** when the **AUTO** or **MANUAL** screen is displayed. So, after programming or making changes, make sure you return to the **AUTO** or **MANUAL** screen. If you fail to do so, the Controller will revert automatically after 4 minutes.

Using the Keys

The   keys control the functions that appear in the lower corners of the screen directly above the keys: **ESC** (Escape) and **OK**; **MANUAL** and **MENU**; or **BACK** and **SELECT**.

Use **OK** to confirm the highlighted selection on the screen, and **ESC** to exit.

Press **MENU** to bring up the **MAIN MENU**. **MANUAL** is used to override automatic programming.

Press **SELECT** to choose the highlighted selection on the screen, and **BACK** to return to the previous screen

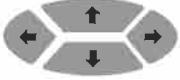
The  arrow keys move the highlighted selection up or down, left or right. In addition, the UP ARROW is used to select and the DOWN ARROW to a selection.

Follow setting procedure step A to F.

A. Setting the Clock

A flashing clock indicates that the time must be set. You will need to set the clock when the power is stopped (such as when battery is changed).

1. Press **MENU**
2. Press up/down arrows until **SET**
3. Press **OK**. **SET MENU** appear and **TIME** is highlighted
4. Press **OK**. The clock face appears
5. Use arrows to set correct time
6. Press **OK**

Time is set.

B. Setting the Day

1. Press **MENU**
 2. Press up/down arrow until **SET**
 3. Press **OK**. **SET MENU** appears and **TIME** is highlighted
 4. Press up/down arrows until **DAY** is highlighted
 5. Press **OK**
 6. Use arrows to select the current day of the week
-

The day is set. You may program the current day (e.g. Monday as Day 1), or the first day of your irrigation cycle as Day 1. In this case, Day 1 could be Saturday or whatever you choose.

C. Setting the Start Times for Programs A and B

Four start times are available. These start times refer to all zones/valves. If the duration is set to overlap the start time of a specific zone, the Controller will reduce the irrigation time to fit into the given time.

You must calculate the start times, duration times and the maximum number of valves that can operate together.

1. Press **MENU**
2. Press up/down arrows until **SET**
3. Press **OK**. **SET MENU** appears and **TIME** is highlighted
4. Press up/down arrows until **STARTS** is highlighted
5. Press **OK** and use up/down arrows to highlight required Start Time
6. Press **SELECT** and use up/down arrows to set minutes
7. Press left arrow to highlight hours and up/down arrows to set hours
8. Press **OK**

Repeat steps 5–8 until all four start times are set according to your requirements.

Calculating Irrigation and Duration Times

When planning your irrigation schedule, you must take into account the maximum number of zones that can operate together. Then carefully calculate the start and duration times to avoid overlap.

If an overlap occurs, the Controller will decrease duration time proportionately over all programmed zones.

FOR EXAMPLE:

Maximum zones: ONE

Start Times: 06:30 ; 10:30 ; 15:30 ; 19:30

Duration Times: Zone 1/Start 1 — 2 hours
Zone 2/Start 1 — 3 hours

In this plan, we have programmed five hours of irrigation for Start 1, but Start 2 commences after four hours.

The Controller will calculate the total irrigation times of both zones and decrease the duration time of both zones proportionately. The result will be that neither Zone 1 nor Zone 2 receives the full irrigation intended.

D. Setting the Duration and Selecting Starts for programs A and B

Each zone can have a different duration time according to the irrigation needs in that area. Each time that zone is operated, irrigation will continue for the duration time programmed for that zone.

Merav - AC Multi-Zone Controller

The duration time programmed refers to the zone that is underlined.

1. Press **MENU**
 2. Press up/down arrows until **SET**
 3. Press **OK**. **SET MENU** appears and **TIME** is highlighted
 4. Press up/down arrows until **DURATION** is highlighted
 5. Press **OK**. **SET DURATION** appears and **ZONE** is highlighted
 6. Press **SELECT** and left/right arrows to highlight zone to be programmed
 7. Press **OK** and up/down arrows until **DURATION** is highlighted and **SELECT** to highlight minutes.
 8. Press up/down arrows to set minutes
 9. Press left arrow to highlight hours and up/down arrows to set hours
 10. Press **OK** and up/down arrows until **SELECT STARTS** is highlighted
-

Merav - AC Multi-Zone Controller

11. Press **SELECT**. The first **START** is highlighted
12. Use right/left arrows to highlight the required **START**
13. Press up arrow to select **START** or down arrow to cancel selection.
Repeat steps 12, 13 for all **STARTS**
14. Press **OK**
15. Press up/down arrows to highlight **ZONE** and repeat above procedure from step 6 until each valve is programmed
16. Press **OK** and **BACK** to complete duration settings

E. Selecting the Program

The Controller has four separate programs.

PROGRAM A irrigates according to the days of the week that you select. It is a Weekly program.

PROGRAM B is an Interval program. You select the interval you require between irrigations e.g. every three days.

PROGRAM C and **PROGRAM D** are Weekly and Interval programs respectively which have been pre-set by the factory and cannot be changed.

Use these programs when you do not want to inadvertently change your programming, and prefer to use the pre-set factory programs.

To select the desired program:

1. Press **MENU**
2. Press up/down arrows until **SET**
3. Press **OK**. **SET MENU** appears and **TIME** is highlighted
4. Press up/down arrows until **PROG. SELECT** is highlighted
5. Press **OK** and use up/down arrows to highlight desired program
6. Press **OK**

Program is selected.

F. Selecting Irrigation Days

After the program has been selected, set the irrigation days. If Program A is selected, you must choose which days of the week each zone will be irrigated.

1. Press **MENU**
 2. Press up/down arrows until **TABLE** is highlighted
 3. Press **OK** and use up/down arrows to highlight zone
 4. Press **SELECT** and use right/ left arrow to highlight day of week
-

Merav - AC Multi-Zone Controller

5. Use up arrow to select day or down arrow to cancel selection
6. Repeat steps 3–5 until all days and zones are programmed
7. Press **OK** and **BACK** to end programming

If Program **B** is selected you must choose the interval between each irrigation. You may choose up to a 14 day interval or OFF for each zone.

1. Press **MENU**
2. Press up/down arrows until **TABLE** is highlighted
3. Press **OK** and use up/down arrows to highlight zone
4. Press **SELECT** and use up/down arrows to highlight interval
5. Use up/down arrows to select number of days interval between irrigation
6. Repeat steps 3-5 until all days and zones are programmed

Other Functions

Manual Operation

You may manually turn on the irrigation in any zone.

Manually operating will irrigate for the duration programmed of that zone.

Merav - AC Multi-Zone Controller

From the Main Screen

1. Press **MANUAL**. The Manual Screen appears
OR
Press **MENU** and use up/down arrows to highlight **MANUAL** and press **OK**
2. Use up/down arrows to highlight the zone
3. Press **SELECT** and use right/left arrows to turn ON or OFF as desired
4. Press **OK** and repeat for each valve
5. Press **OK** and **BACK** to return to Main Screen

MANUAL	ON	OFF
ZONE 1		X
ZONE 2		X
ZONE 3		X
ZONE 4		X
ZONE 5		X
ZONE 6	✓	
ZONE 7		X
ZONE 8	✓	
BACK		SELECT

NOTES: Pressing **AUTO** will cancel Manual operation.
MANUAL operation will only apply after returning to the main screen.

Viewing Programmed Table

1. Press **MENU**
 2. Press up/down arrows until **TABLE**
 3. Press **OK**
-

Merav - AC Multi-Zone Controller

Table showing zones and selected irrigation days is displayed. You may also change selections for Program A or B (see pages 17, 18). Programs C and D are pre-set and may be viewed here, but not be changed.

Setting Rain Delay

If rain has enabled you to postpone irrigating, you may program the Controller to delay all irrigation for up to 14 days.

1. Press **MENU**
2. Press up/down arrows until **RAIN DELAY**
3. Press **OK**
4. Use up/down arrows to enter number of days to delay irrigation e.g. 3
5. Press **OK** and **ESC** to return to main screen

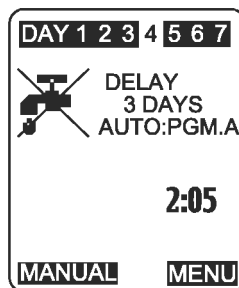

DELAY 3 DAYS will appear on main screen, and the number will decrease as days pass.

NOTE: One day delay will stop irrigation till midnight.

Seasonal Adjustment

If local conditions (e.g. rain or heat wave) necessitate a change in irrigation, this may be done with one simple adjustment. For example, programming the seasonal adjustment to 110% will increase the duration times by 10%, while entering an adjustment of 50% will halve the duration times. Any deviation from 100% will appear on the **AUTO** screen display. Minimum is 10% and maximum is 200%.

To program seasonal adjustment:

1. Press **MENU**
2. Press up/down arrows until **SEASONS**
3. Press **OK**
4. Use up/down arrows to enter percentage change required. e.g. 120%

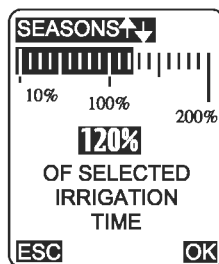

5. Press **OK** and **ESC** to return to Main Menu

SEASON ...120% appears on main screen.

Merav - AC Multi-Zone Controller

Off

To turn off the valves:

1. Press **MENU**
2. Press up/down arrows until **OFF**
3. Press **OK**

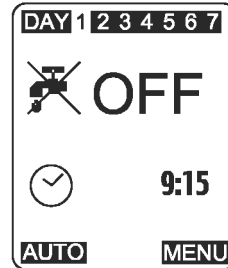

OFF appears and no irrigation will occur.

To cancel, select **AUTO** and the Controller reverts to its normal operation.

Run-Test

Perform a Run-Test to test the operation of all valves.

- 1/ Electric test for short-cut or disconnection. Each valve operates for one second.
- minute trial, each valve
in turn, one after the other.

NOTE: Run-Test disrupts all operating programs. When the Run-Test is complete, the Controller will resume irrigating according to the programmed setting.

1. Press **MENU**
2. Press up/down arrows until **OPTIONS**
3. Press **OK** and **OPTIONS** menu appears with **RUN TEST** highlighted
4. Press **SELECT** and use up arrow to select **ON**
5. Press **OK**

Sensor

There are two basic types of sensors, normally open (N.O.) or normally closed (N.C.), and the Controller may operate with either. If you connect a sensor, you must define which type you are using, and which zones are connected.

1. Press **MENU**
2. Press up/down arrows until **OPTIONS**
3. Press **OK** and **OPTIONS** menu appears
4. Use up/down arrows to highlight **SENSOR**
5. Press **SELECT** and use up/down arrows to select **N.C, N.O.** or **OFF**
6. Press **OK** and use arrows to select or cancel zones that are connected to the sensor
7. Press **OK** and **BACK**

When the sensor detects the required moisture levels, **SENSOR ON** appears on the main screen and the operating valves will turn off, or valves programmed to open will remain closed.

Setting Maximum Number of Zones

The maximum number of zones that can operate together may change according to water pressure and other local conditions. The Controller can operate a maximum of 3 zones at one time, and you must program from 1-3 as desired.

Merav - AC Multi-Zone Controller

1. Press **MENU**
2. Press up/down arrows until **OPTIONS**
3. Press **OK** and **OPTIONS** menu appears
4. Use up/down arrows to highlight **MAX ZONES**
5. Press **SELECT** and use up/down arrows to select the maximum number of zones (1 or 2 or 3).
6. Press **OK** and **BACK**

Selecting a Language

1. Press **MENU**
2. Press up/down arrows until **OPTIONS** is highlighted
3. Press **OK** and **OPTIONS** menu appears
4. Use up/down arrows to highlight **SET LANGUAGE**
5. Press **SELECT** and use arrows to select language
6. Press **OK** and **BACK**

Restoring Default Settings

The Controller is programmed at the factory with default settings that may be restored at any time.

The default settings are:

START TIMES

START 1 06:30

START 2 10:30

START 3 15:30

START 4 19:30

MAXIMUM NUMBER OF ZONES

One

The default irrigation schedules for Programs A and B appear on pages 25, 28.

To restore default settings:

1. Press **MENU**
2. Press up/down arrows until **SET**
3. Press **OK**. **SET MENU** appears and **TIME** is highlighted
4. Press up/down arrows until **DEFAULT** is highlighted
5. Press **OK**
6. **RESTORE FACTORY SETTINGS** appears on screen. Press **OK**

Default settings are restored.

Troubleshooting

Problem	Possible Cause	Solution
Valve does not open at set time OR Irrigation stops OR No AC	<ol style="list-style-type: none"> 1. Controller is set to MANUAL 2. AC failure 3. Clock or day is incorrectly set. 4. Faulty solenoid connection 5. Sensor detected moisture and stopped program 6. Zone - failure 	<ol style="list-style-type: none"> 1. Press AUTO 2. Change battery 3. Set clock & day 4. Check all connections 5. Check moisture levels 6. Change sol. and run test.
Screen is blank	No display when inactive	Touch any key to activate
Cannot change settings	Program is set to C or D (pre-set programs)	Change program to A or B
Irrigation stops before completing duration time	Start times and duration times overlap	Recalculate programmed times (see page 14)
Manual operation does not work	Did not return to Main screen after changes in programming	Press OK and BACK to return to Main screen (Manual)

IRRIGATION TABLES

PROGRAM A															
ZONE	DURATION	STARTS				DAY OF WEEK									
						1	2	3	4	5	6	7			
1		1	2	3	4										
2															
3															
4															
5															
6															
7															
8															

PROGRAM B							
ZONE	DURATION	STARTS				INTERVAL	
		1	2	3	4		
1		1	2	3	4		
2							
3							
4							
5							
6							
7							
8							

Merav - AC Multi-Zone Controller

PROGRAM A DEFAULT SETTINGS FOR													
ZONE	DURATION	STARTS				DAY OF WEEK							
						1	2	3	4	5	6	7	
1	0:05	✓	✓	✓	✓	✓	✓	✓	✓	✓	✓	✓	✓
2	0:05	✓	✓	✓	✓	✓	✓	✓	✓	✓	✓	✓	✓
3	0:30	✓				✓		✓		✓			✓
4	0:30	✓				✓		✓		✓			✓
5	1:00				✓	✓			✓				
6	1:00				✓	✓			✓				
7	2:00	✓						✓					
8	2:00	✓						✓					

PROGRAM B DEFAULT SETTINGS FOR						
ZONE	DURATION	STARTS				INTERVAL
1	0:05	✓	✓	✓	✓	1
2	0:05	✓	✓	✓	✓	1
3	0:30	✓				2
4	0:30	✓				2
5	1:00				✓	3
6	1:00				✓	3
7	2:00	✓				6
8	2:00	✓				6

Contact and Service

GUARANTEE

Baccara products are guaranteed to be free from defects in material and workmanship for a period of one year from the date of delivery.

This guarantee does not apply where equipment is not used and installed strictly in accordance with *Baccara* specifications and Users Guide. Neither does it apply to failures caused by lightning strikes or damage due to freezing temperatures or mechanical causes (e.g. lawn mowers). *Baccara* is not liable for indirect, incidental or consequential damage in connection with the use of equipment.

To receive guarantee benefits, customers should return defective units along with the receipt to the nearest *Baccara* distributor.

Baccara reserves the right to alter, modify or redesign its products, pricing and warranty at all times without creating any liability for the obsolescence of customer inventory of such parts or products.

This manufacturer guarantee policy may apply differently in different countries.

Merav - AC Multi-Zone Controller

Contact Information

FACTORY AND HEAD OFFICE

**Baccara Automation Control
Kvutzat Geva, 18915, ISRAEL**

Tel: 972 4 6535960

Fax: 972 4 6531445

E-mail: baccara@netvision.net.il

Web-Site: www.baccara.co.il

